



HEAT RECOVERY

Trust in LUNOS

Fresh air for generations

LUNOS is a Berlin-based company and market leader for decentralised residential ventilation systems. The company was founded in 1959 and still has its headquarters in Berlin-Spandau. In 2019, LUNOS established a second location in Brandenburg. With a modern high-bay warehouse and new laboratories, the company has prepared itself for the future. LUNOS products are made in Germany and sold in over 36 countries worldwide. In Germany, the products are sold via the three-stage distribution channel.

LUNOS stands for more than a living climate

Because fresh air is important for people, as well as for houses and flats. The core competencies of LUNOS are decentralised controlled residential ventilation with and without heat recovery as well as the development and manufacture of energy-efficient fans and external wall diffusers. In addition, LUNOS develops all associated components as well as many other products such as exhaust air fans and facade ventilation systems with concealed ventilation openings.

For decades LUNOS stood for highest quality, functionality and comfort. Ventilation systems, with or without heat recovery, improve the indoor air quality in your home and save energy in everyday life at the same time.

Made in Germany



INFORMATION

On our homepage www.lunos.de/en you will find data sheets, user information and much more.





Controlled home ventilation

System with heat recovery

02 SYSTEM WITH HEAT RECOVERY

With this particularly efficient system, all rooms in the residential unit are equipped with heat recovery units - exactly where they are needed. If you are interested in this type of ventilation, we recommend our proven e² series fans.

e² series **A** **A+**

Axial external wall ventilators with regenerative heat recovery for living rooms and bedrooms, can be combined with LUNOtherm-S und LUNOtherm-S+.



e⁹⁰ **A**

Exhaust fan with heat recovery for functional rooms.



Ne^{xt} **A**

Radial external wall ventilator with recuperative heat recovery for living rooms, bedrooms and functional rooms. Wall ducting via 160 mm round duct.



9/MRD

Wall-mounted housing to accommodate the 160 round duct. H x W x D: 240 x 210 x 500 mm



LUNOtherm-S and -S+

Facade element, without disturbing ventilation grille on the facade.





02 SYSTEM WITH **HEAT RECOVERY**

With this system, all rooms of the residential unit are equipped with fans with heat recovery. These are particularly recommended in the living and sleeping areas.

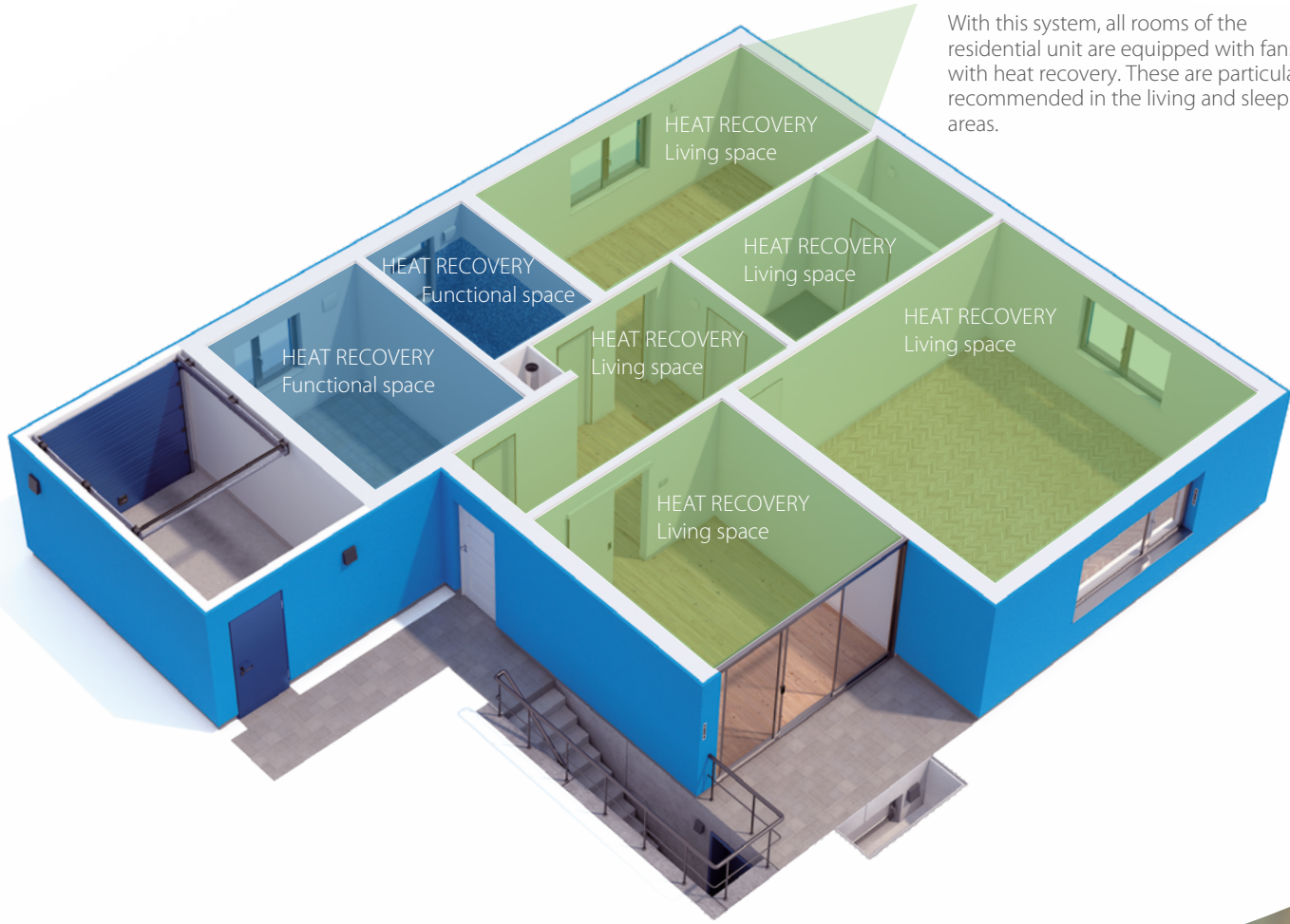

e² series

Flexible in any field

No fan has the decentralized ventilation with heat recovery so characterized like the e² from LUNOS.

e²60short

The e²60 for narrow outer walls from 200 mm wall thickness

e²short

The short one: for small outside walls from 200 mm wall thickness



e²60

The powerful one: constant pressure with a volume flow from 5 - 60 m³/h

e²

The classic: proven and efficient for use in living room and bedroom

e² series

Technical Data



Characteristics	e ² 60	e ² 60short	e ²	e ² short
Volume flow	5 - 60 m ³ /h	5 - 60 m ³ /h	15 - 38 m ³ /h	15 - 38 m ³ /h
Max. degree of heat supply	96 %	89 %	94 %	88 %
Heat supply level according to EN 13141-8 at reference volume flow	20 m ³ /h: 96 % 40 m ³ /h: 90 % 60 m ³ /h: 85 %	40 m ³ /h: 83 % 60 m ³ /h: 80 %	20 m ³ /h: 93 % 38 m ³ /h: 91 %	20 m ³ /h: 85 % 38 m ³ /h: 80 %
Heat supply level according to DIBt*, abZ-number	85 % Z-51.3-455	89 % Z-51.3-479	90 % Z-51.3-450	86 % Z-51.3-450
Max. standard sound level difference D_{n,e,w}	67 dB	67 dB	54 dB	54 dB
Sound power level L_W	from 18 dB(A)	from 18 dB(A)	from 29 dB(A)	from 28 dB(A)
Power consumption	0,4 - 3,3 W	0,4 - 3,3 W	0,7 - 4,0 W	0,6 - 3,9 W
Minimum installation length	280 mm (lower on request)	200 mm	280 mm	200 mm
Dimensions	Plug-in module Ø 154 x 243 mm	Plug-in module Ø 154 x 160 mm	Plug-in module Ø 154 x 243 mm	Plug-in module Ø 154 x 168 mm
Compatibility	All 160 systems incl. LUNOtherm and external hoods as external finish	All 160 systems incl. LUNOtherm and external hoods as external finish	All 160 systems incl. LUNOtherm and external hoods as external finish	All 160 systems incl. LUNOtherm and external hoods as external finish
Energy efficiency class	A+	A	A	A

* When using the wall-mounted housing 9/MRD as insulation, without 9/MRD 2% deduction.
All data are mathematically rounded.

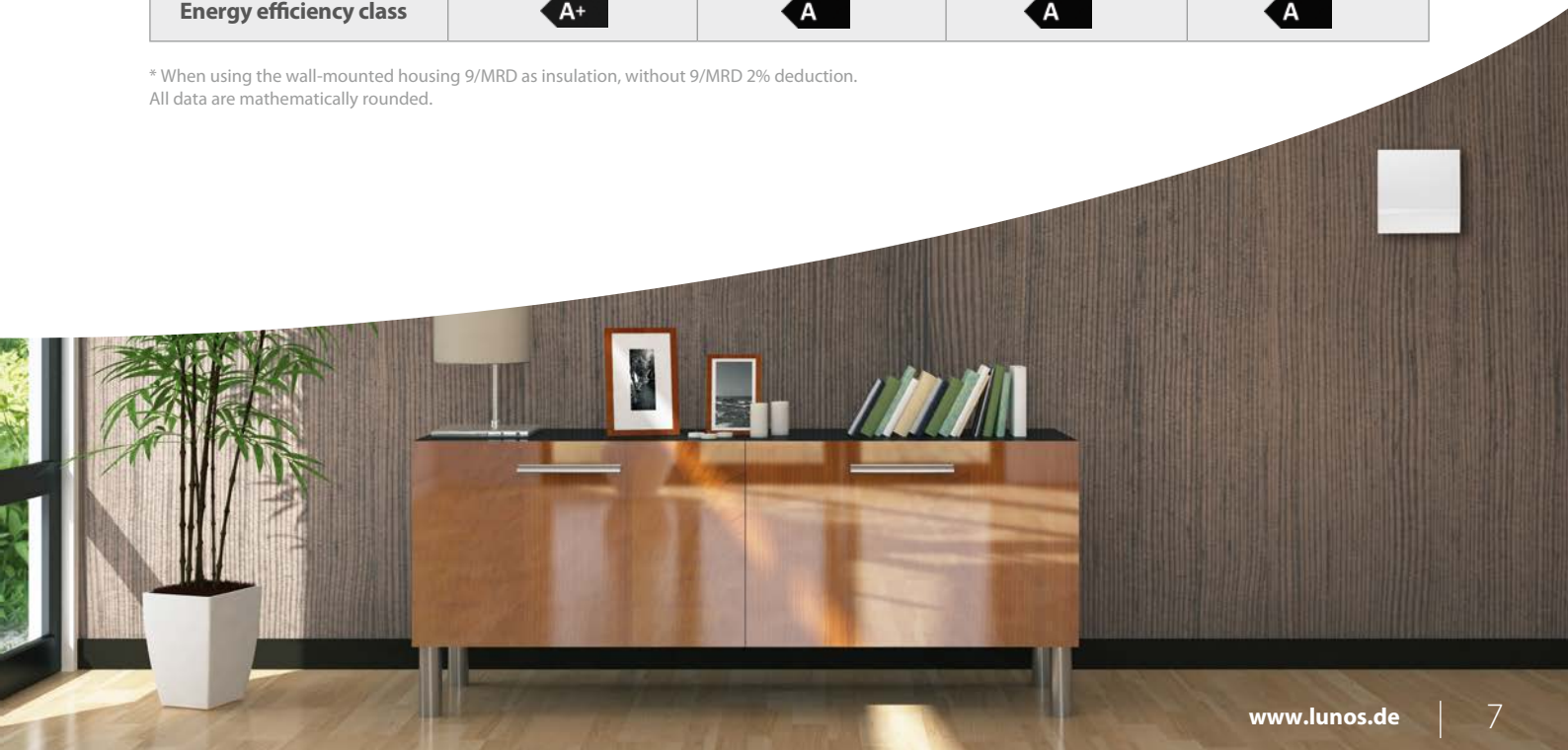

e²60
e²60short

[esquaredsixty]
[esquaredsixtyshort]

Ready for the demands of the future.

Thanks to its very low power consumption and intelligent motor control, the e²60 is extremely energy efficient and easily achieves energy efficiency class A+.



Highly efficient heat accumulator with a degree of heat provision of 90 % resp. 83 %

Patented air diffuser for optimal inflow

Noise-optimised fan unit with pressure-constant ec-motor

Inner screen with washable G3 filter



e²60 and e²60short

The reference units in their class

With classified wind pressure stability and high volume flows, the e260 is a reference device in its class.

The consequent improvement of the ec-technology and the wing aerodynamics ensures particularly low noise emissions.

The fact that the e²60 achieves the high heat provision level of 96 % is largely due to the newly developed and patented air diffuser, which ensures a particularly even

flow through the heat exchanger.

The e²60 is the first axial fan to achieve a constant volume flow at high back pressures. This outstanding feature of external motor control ensures that the e²60 is the first unit of its type to meet the requirements of pressure class S1 according to DIN 13141-8. This makes it easy to use in

areas with high wind pressures, such as on the coast or at high altitudes. A further advantage of the e²60 is its high volume flow bandwidth.

With the smaller heat accumulator of the e²60short, the range of application is extended to slim outer walls with a wall thickness of 200 mm or more.

Can be combined with inner screens of the 160 series



F7*-FILTER

Special pollen and fine dust filters that simply leave annoying particles outside. F7*-filters included with IBG-H and IBK-H.



*Equivalent to 55% according to ISO 16890 ePM1.



Ne^{xt}

Heat recovery unit

The Ne^{xt} is not only suitable for home ventilation, but also for use in kindergartens, schools, offices, hotels and medical practices. The Ne^{xt} also delivers the best results in areas or heights where extraordinary wind loads prevail and in areas where high sound insulation is required.

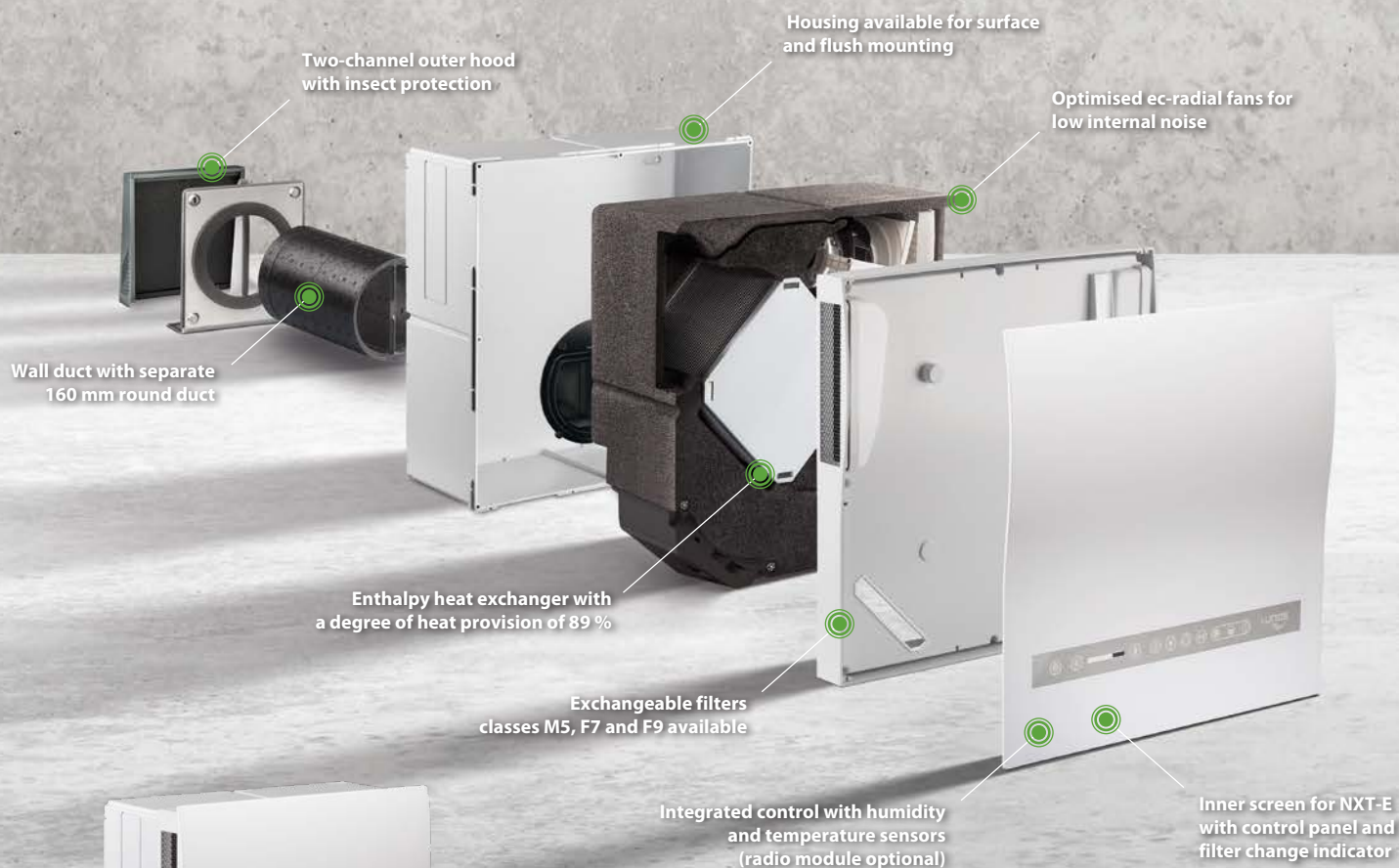

Ne^{xt} NXT with 9/NXT-IB for external regulation wireless or by control

Ne^{xt}

Heat recovery unit



Low noise level and maximum passive soundproofing

The Ne^{xt} is extremely energy-efficient thanks to its very low power consumption: the ec technology with high efficiency enables low power consumption.

The integrated controller ensures perfect interaction between the various components. Equipped with humidity-temperature sensors, the automatic control system ensures efficient ventilation with moisture protection even in the standard version. Optionally, the Ne^{xt} can be equipped with the FM-EO radio module for control and communication with other LUNOS components and for SmartHome integration. The heart of the Ne^{xt} is the plug-in unit with enthalpy heat exchanger, which is equipped with innovative membrane technology

and achieves a heat recovery rate of up to 96 %. In addition, the mode of operation of the heat exchanger ensures that it is largely ice-free and provides comfort in the interior due to the additional re-humidification.

Ne^{xt} NXT-E

Equipped with an integrated control element in the inner screen, the NXT-E can be operated directly on the unit.

Ne^{xt} NXT

The NXT differs from the NXT-E only in its control capability. The required external regulation can be taken over by all 12 V controls from LUNOS.

OPTIONAL FM-EO

Wireless module for bidirectional wireless transmission

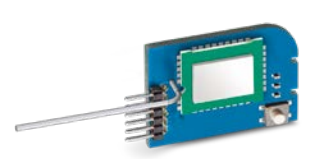

OPTIONAL F9**-filters

For highest demands on hygiene. Already equipped with F7*-filters as standard.



*Equivalent to 55% according to ISO 16890 ePM1.
 **Equivalent to 80% according to ISO 16890 ePM1.

OPTIONAL

Electrical flap closure

Electrical flap closure 9/KVEN-2 for Ne^{xt} based on the 160 round duct. It opens or closes the panel feed-through automatically when the unit is switched on or off

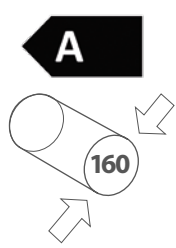



Recommendation

As an extension of the range of functions and for the use of logging functions, LUNOS recommends the use of the diagnostic software.



The modular system for the perfect fan

PLUG-IN UNIT	HOUSING	ROUND DUCT + ADAPTER*	INNER SCREEN	EXTERNAL CLOSURE				
 <p>NXT-E Plug-in unit</p>	 <p>3/NXT Installation housing Flush mounted</p>	 <p>9/R 160-500 500 mm length 9/R 160-700 700 mm length</p>	 <p>9/NXT-IBF with foil keypad suitable for plug-in unit NXT-E</p>	 <p>1/KWE, 1/HWE-2 Universal hood and Two-channel outer hood</p>				
or	+	or	+	and	+	or	+	or
 <p>NXT Plug-in unit</p>	 <p>3/NXT + 3/NXT-AP Installation housing Surface-mounted set</p>	 <p>2/AD 160 Adapter*</p>	 <p>9/NXT-IBF without foil keypad suitable for plug-in unit NXT</p>	 <p>1/KAZ, 1/HAZ-2 Universal hood and Two-channel outer hood</p>				

*From 30 cm an adapter is required for each 10 cm or part thereof of the round duct.



Ne^{xx}t

Technical data



Characteristics	NXT-E and NXT
Volume flow	15 - 110 m ³ /h
Max. degree of heat supply	96 %
Heat supply level according to EN 13141-8 at reference volume flow	25 m ³ /h: 96 % 50 m ³ /h: 89 % 75 m ³ /h: 84 %
Max. standard sound level difference $D_{n,e,w}$	49 dB
Sound power level L_W	from 20 dB(A)
Power consumption*	22 W
Supply voltage	200-240 V 50/60 Hz (115 V 60 Hz on request)
Core drilling	162 mm
Minimum installation length	Surface-mounted: 110 mm, flush-mounted: 280 mm
Depth for wall mounting	172 mm Housing + 105 mm Flap closure in wall ducting
Dimensions of the device	480 mm x 480 mm x 170 mm
Size inner screen	510 mm x 510 mm x 66 mm
Size outer hood	235 mm x 205 mm x 72 mm
Energy efficiency class	A
Protection class	IP22

*At 70 % of the maximum volume flow, according to ErP Directive, EU Regulation 1254/2014. All data are mathematically rounded.

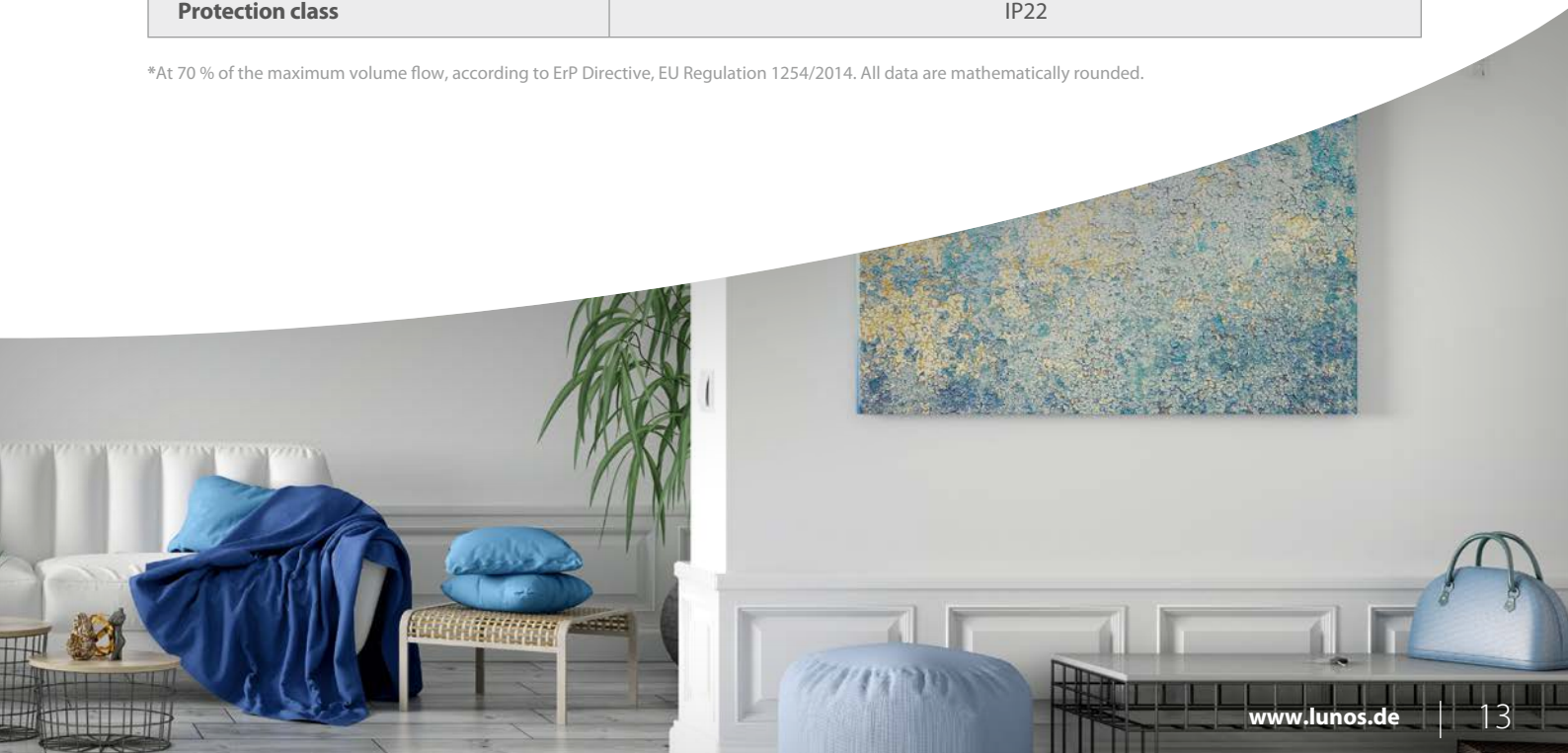

Reversing technology for exhaust air rooms

For bathrooms, WCs and kitchens





Supply and exhaust air in one unit

In one e⁹⁰, two fans provide simultaneous air supply and exhaust. Therefore, operation in pairs is not necessary.

The e⁹⁰ ensures optimum ventilation with heat recovery in bathrooms, WCs and kitchens. It combines supply and exhaust air by means of two small fans located inside the fan.

The e⁹⁰ is one of the world's smallest fans for domestic ventilation with heat recovery in the two-channel unit class.

Outer hood

The e⁹⁰ can be combined with the universal hood and the two-channel outer hood on the facade



TECHNICAL DATA

Volume flow
5 - 20 m³/h (heat recovery), 45 m³/h (exhaust)

Max. degree of heat supply
92 %

Heat supply level*
91 %

Max. standard sound level difference D_{n,e,w}
46 dB

Sound power level L_w**
from 28 dB(A)

Power consumption
1 - 4,9 W

Supply voltage
12 V DC SELV

Core drilling
Ø 162 mm

Minimum installation length
300 mm

Dimensions
Screen 237 x 217 mm
Plug-in module Ø 154 x 300 mm

Protection class
IP22

*According to EN 13141-8 at reference volume flow.

**Sound power level:
The sound power level indicates how "loud" a device is. The value is independent of the distance. All data are mathematically rounded

e⁹⁰



Inner wall air vent ILD

Active cross-flow element for installation in interior walls

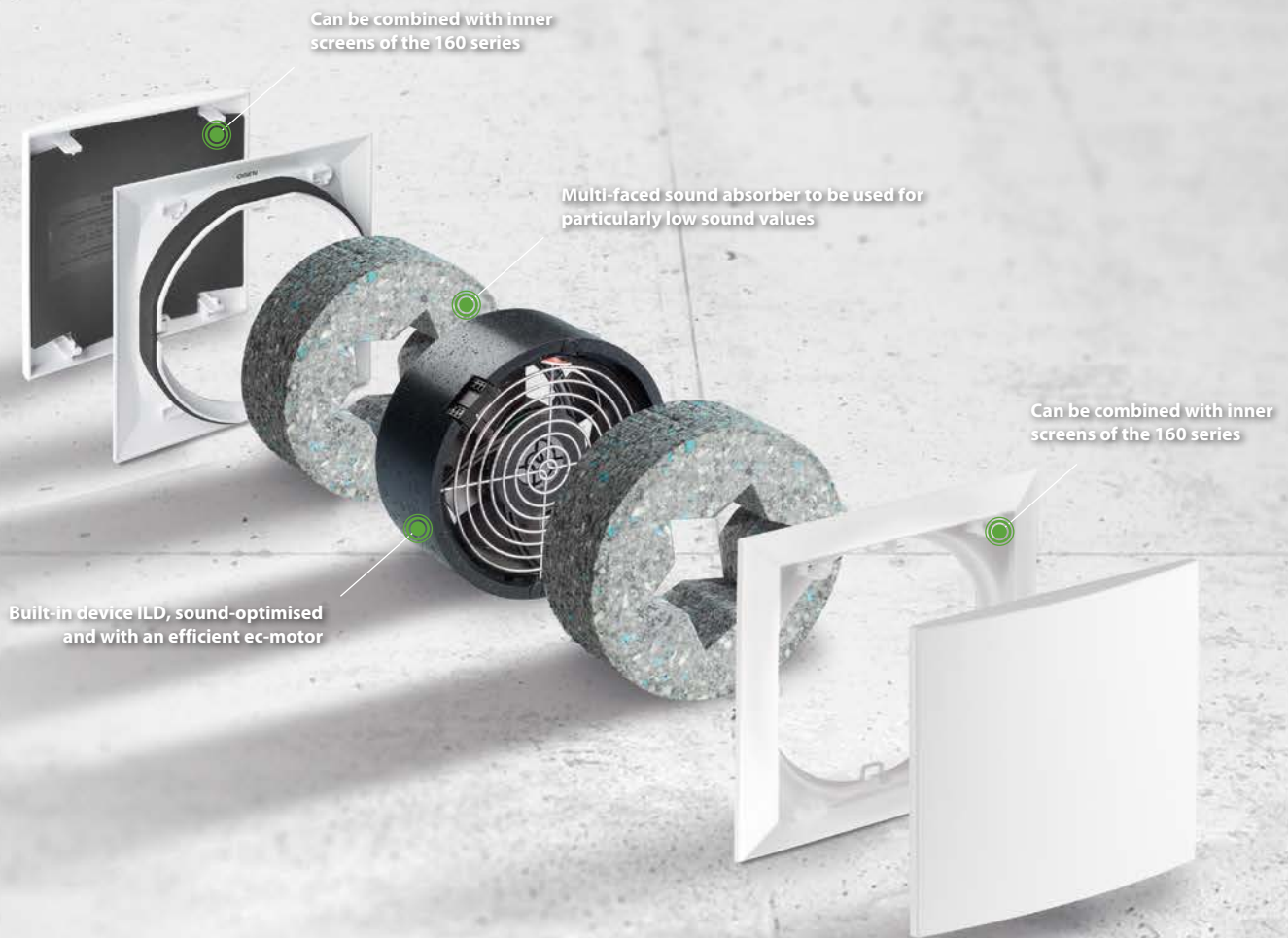

Compatibility

ILD can be combined with all exhaust air systems, ALD, the e² series, as well as e⁹⁰, Ne^{xt} and LUNOMAT. Synchronized conveying directions and volume flows can be established or independently controllable (ILD) systems can be set up.



Inner wall air vent ILD

Ventilation for previously out-of-reach rooms

Easy ventilation of adjoining rooms in combination with the existing ventilation control or via a separate control with the new ILD from LUNOS

The active cross-flow element ILD is set up using the 160 modular system and can be equipped with sound absorbers and two inner screens in addition to the fan insert ILD.

The application area of the ILD are interior rooms that must be ventilated via another room. If there is no external wall available in a living space, then one or more ILDs can be used to create a coupling with

other rooms and thus establish an active air connection.

For example an e² ventilation system can be installed in a bedroom (=primary room) and an adjacent interior side room (=secondary room) can be ventilated by an ILD. The ILD is the ideal supplementary ventilator for **cascaded ventilation** in a living space.

Can be combined with inner screens of the 160 series.



Standard inner screen



Comfort inner screen (plastic design)



Comfort inner screen (glass design)



Sound insulation Inner screen



Wireless screen with integrated control system

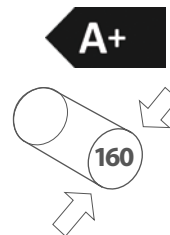

TECHNICAL DATA

Volume flow
26 - 40 m³/h

Sound power level* L_W
from 33 dB(A)

Power consumption
0,7 - 1,5 W

Supply voltage
12 V DC SELV

Core drilling
Ø 162 mm

Minimum installation length
100 mm

Dimensions
Built-in unit Ø 154 x 60 mm

Cascaded ventilation

The term cascaded ventilation is used to describe the interconnection of living spaces that cannot be ventilated independently of each other.

The directly ventilated room (with an installed ventilation system) is called primary room and the cascaded ventilated room (without a directly installed ventilation system) is called secondary room. For example, the bedroom with e² is the primary room and the adjacent dressing room is the secondary room. Only rooms of the same or similar type of use should be connected. Air flows from the primary to the secondary room and should therefore not come from bathrooms, toilets, kitchens or utility rooms to prevent odour transfer.

For example, bedrooms can easily be cascaded with children's rooms, and living rooms can be cascaded with work rooms or storage rooms.

Sound power level:
The sound power level indicates how "loud" a device is. The value is independent of the distance.
All figures are mathematically rounded.

ILD



LUNOMAT

Central home ventilation unit

Fresh air supply of the living areas,
by pressure-resistant and highly efficient
ec radial motors for volume flows
up to 125 m³/h.

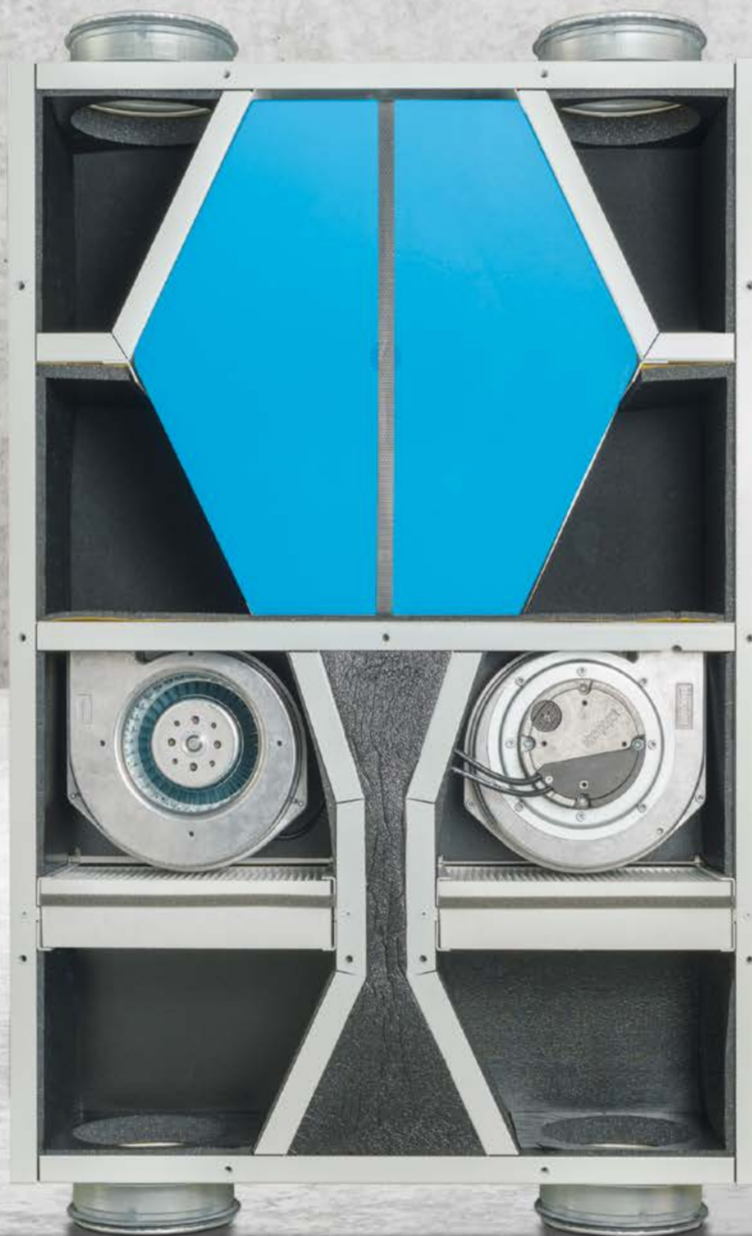

LUNOMAT

The central home ventilation unit from LUNOS



Highly efficient enthalpy heat exchanger with a heat supply efficiency of up to 95 %

With a highly efficient enthalpy heat exchanger and a heat supply level of up to 95%, the LUNOMAT is the performance professional for the supply of fresh air to living spaces.

Thanks to exchangeable filters of the class F7, the LUNOMAT can be adapted to the most diverse requirements. The pressure-resistant and highly efficient ec radial motors are also suitable for volume flows of up to 125 m³/h at 100 Pa and ensure optimum air distribution via an appropriate duct network.

In short: The LUNOMAT is the all-round talent from LUNOS for central apartment ventilation.

The LUNOMAT can be operated by all LUNOS control systems: TAC, Smart Comfort, universal control and gesture control. Of course, it is also possible to receive commands from the common smart home controls or homee via optional wireless modules.

OPTIONAL **F7*-Filter**

Exchangeable filters of class F7 available



A

*Equivalent to 55% according to ISO 16890 ePM1.

TECHNICAL DATA

Volume flow

40 - 125 m³/h at 100 Pa

Max. degree of heat supply

95 %

Heat supply level*

75 m³/h: 92 %

100 m³/h: 87 %

125 m³/h: 85 %

Heat supply level according to PHI

83 %

Device sound

at 100 m³/h, 100 Pa

45 dB(A)

Specific

Power consumption (SPI)

at 50 Pa*

0,3 W/(m³/h)

Max. power consumption

at 125 m³/h, 100 Pa

52 W

Mains voltage

100 - 240 V | 50/60 Hz

External and internal leakage

Klasse A1

Dimensions (H x W x D)

805 x 555 x 190 mm

Installation options

New construction and renovation

Ceiling and wall mounting

4 x DN 125 mm Outlets

*According to EN 13141-7 at reference volume flow. All data are mathematically rounded.

LUNOMAT

Controls

Whether with gesture or automated

LUNOS offers control systems that can be adapted exactly to the wishes and requirements.

5/UNI-FT & 5/UNI-RF

Can be controlled automatically, standard with humidity/temperature control and time delay module, 5/UNI-RF with integrated LUNOS wireless module, wireless module UNI-EO connectable

Gesture Control

Contactless controllable with 60 RGB LEDs and many standby display options

Wireless screen

An independent, wireless control unit integrated in a smart design screen



Smart Comfort & Smart Comfort wireless

Especially easy to operate: one touch of a button is enough, wireless module UNI-EO connectable

TAC

The all-rounder from LUNOS can be configured for the most diverse ventilation scenarios



Gesture Control

Universal controllers and devices of the Ne^{xt} and/or Silvento ec series can be connected to the two outputs of the Gesture control.

More than with other ventilation systems, decentralised ventilation is about effectiveness and the sensible addition of the various fans in the system. For the optimal implementation of energy-efficient ventilation, control systems are required that network the ventilation system in a meaningful way while ensuring easy operation.

LUNOS provides different types of control: the Universal Control, the Touch Air Comfort, the Smart Comfort and the Gesture Control.

The universal control as well as the Smart Comfort are also available as **LUNOS wireless** variants **5/UNI-RF** and **5/SC-RF** with integrated wireless module. Just like the wireless screen, they can be easily coupled with each other via the LUNOS wireless protocol and also have a slot for the UNI-EO wireless module. This makes it possible to control the connected fans via home automation systems or homee.

Wireless screen with 5/UNI-RF

The complete technology under one screen



The wireless screen combines elegant design for the living room with the control technology of the universal control. The built-in 5/UNI-RF with humidity and temperature sensors has an integrated wireless module that allows communication with other 5/UNI-RF controls and wireless screens without additional wiring. Other LUNOS wireless products or smart home controls with UNI-EO wireless module can be connected.

The wireless screen is also available as a pure design screen without wireless control.

Functions

- » Including power supply unit for direct connection to 230 V, 50/60 Hz.
- » Built-in 5/UNI-RF with integrated wireless module for connection with further 5/UNI-RF controls and wireless screens
- » UNI-EO radio module can be connected
- » Automatic humidity control
- » Three different humidity control ranges adjustable
- » Manual control via pushbutton on the screen (four-stage) or optional connection of external switches possible
- » Integrated delay time and interval operation
- » 0 - 10 V input for connection to the TAC or to the home automation system

Optional device combinations

All 12-volt fans* of the LUNOS 160 series can be controlled with the wireless screen 9/IBF-RF. As a design solution for all ALD and fans without wireless technology, the wireless screen 9/IBF is also available as a pure screen without wireless control.

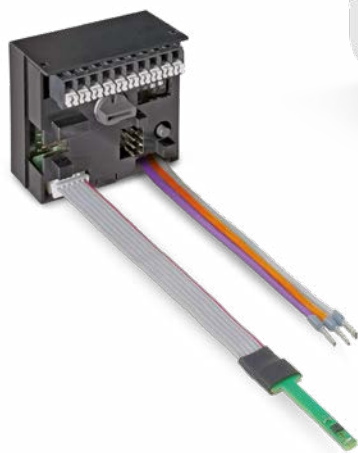

*except e90

Wireless technology

For easy smart home connectivity

A wireless technology that meets the high requirements of LUNOS must be extremely energy efficient and safe.



LUNOS wireless system

The LUNOS wireless system is a stand-alone system that transmits bidirectionally at 868 MHz. 5/UNI-RF, 5/SC-RF and the wireless screen 9/IBF-RF are equipped with LUNOS wireless modules and can be connected to the homee Smart Home central unit or to other Smart Home systems via the UNI-EO wireless module.



LUNOS wireless system Universal control wireless and Smart Comfort wireless with LUNOS wireless module

LUNOS wireless system & Smart Home:

An EnOcean module makes the LUNOS wireless system smart.



The bidirectional wireless technology transmits reliable signals with very small amounts of energy.

For the connection of LUNOS wireless products to the Smart Home, it is enough to equip them with an EnOcean module.

The transmitters with EnOcean modules can be operated partly without batteries and therefore with low maintenance. The necessary energy is generated by the

piezoelectricity of switches or solar cells. In order to control the ventilation system via smartphone, tablet or computer, LUNOS recommends the use of the homee Smart Home central unit, which already has a WLAN interface as standard and thus provides for the connection to the Internet. With the EnOcean extension module from homee the LUNOS wireless modules are integrated into the smart home control center.

Wireless technology

Products for ventilation in the smart home



**Remote control
RC-EO**

The RC-EO remote control is battery-free, shock and splash-proof and is therefore suitable for all areas of everyday life. Coupled with the UNI-EO module or the FM-EO wireless module, all connected devices can be controlled by radio command. Via the two available channels, volume levels can be switched and special functions activated and deactivated.



**Flush-mounted module
UPM-EO**

The UPM-EO flush-mounted module is a transmitter and receiver for wireless signals. Connected to a simple push-button or series switch, such as our 5/W2T, switching commands can be transmitted by radio. This is how a simple fan, such as the AB 30/60, becomes wireless. Especially during renovation work, this allows the fan to be operated manually at a later date without the need for complex cable laying.



**External Humidity Temperature
Sensor SFT-EO**

The external humidity temperature sensor SFT-EO can be installed almost anywhere and does not require any additional power supply. If you have coupled the SFT-EO as an indoor sensor to the UNI-EO or FM-EO modules, the values of the wireless sensor and internal sensors are compared and ventilation is based on the climatic conditions thus transmitted. When coupled as an outdoor sensor with the UNI-EO module, the intelligent control unit compares the absolute values of indoor and outdoor climate and adjusts the ventilation accordingly.



**Wireless screen 9/IBF-RF and
wireless controls 5/UNI-RF & 5/SC-RF**

The wireless screen **9/IBF-RF** combines elegant design for the living room with the control technology of the universal control. It is equipped as standard with the 5/UNI-RF with humidity and temperature sensor and the integrated LUNOS wireless module and a power supply unit for direct connection to 230 V, 50/60 Hz.

The wireless controls **5/UNI-RF** and **5/SC-RF** have all the functions of the proven 5/UNI-FT and 5/SC-FT. Thanks to the wireless module integrated as standard, it enables communication with LUNOS wireless products. Communication with EnOcean products or Smart Home controls is possible via the EnOcean wireless module UNI-EO without additional wiring.

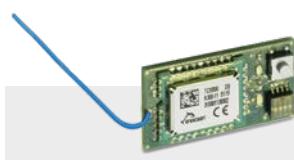

**Wireless module UNI-EO
for universal control**

The UNI-EO wireless module is used for universal control and Smart Comfort and ensures constant communication with the coupled LUNOS wireless components. This includes both the processing of received sensor values and switching commands as well as the transmission of system states. Automatic modes can be extended and optimized. The control system can also adapt the operation of the connected devices to linked ventilation components. For example, it is possible for connected e² devices to actively supply supply air when an exhaust fan transmits a switched demand ventilation by a wireless command.

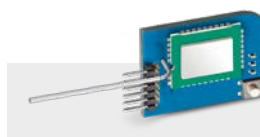

**Wireless module FM-EO
for Silvento ec and Ne^{xt}**

The FM-EO wireless module is compatible with all Silvento ec and Ne^{xt} models. In the exhaust air system, the Silvento ec and the ventilation behaviour can also be optimised with the coupled outdoor sensor SFT-EO. In conjunction with e² fans on a universal control unit with UNI-EO module, sensor values can be exchanged and the ventilation operations of the systems can be coordinated. The same applies to the combination Ne^{xt} and Silvento ec. If several Ne^{xt} units are operated in one utilisation unit, a temperature-controlled ventilation operation can be achieved by targeted cross-ventilation of the units among themselves. It is also possible to react efficiently to varying outside temperatures and to keep the inside temperature constant.

Inner screens

160 series

Comfort inner screen

The direct sound impact on the resident is reduced - the result is a more pleasant living experience. The glass variants also impress with their elegant and modern design.



In plastic design

(H x W x D) 191 x 180 x 60 mm

Description: **9/IBK**



In plastic design

incl. F7 filter,
increased hygiene protection
(H x W x D) 191 x 180 x 77 mm
Description: **9/IBK-H**



In glass design

(H x W x D) 197 x 185 x 66 mm

Description: **9/IBG**



In glass design

incl. F7 filter,
increased hygiene protection
(H x W x D) 197 x 185 x 83 mm
Description: **9/IBG-H**

Standard inner screen

Simple screen with timeless elegance for universal use in the 160 series.



(H x W x D) 180 x 180 x 35 mm

Description: **9/IBE**

Wireless screen

Elegant design screen including wireless control and power supply unit for all 12V units of the 160 series.



(H x W x D) 230 x 185 x 53 mm

Description: **9/IBF-RF**

Sound insulation inner screen

Increase of the standard sound level difference by up to 6 dB, reduction of the inherent noise, incl. washable filters, one piece each of filter class G2 and G3

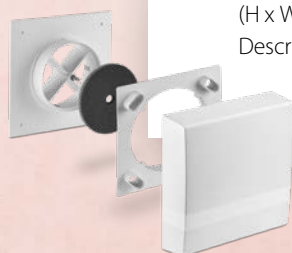

(H x W x D) 250 x 250 x 78 mm

Description: **9/IBS**

External grille & outer hoods

Round, square & soundproofed



Plastic grille Ø 180 mm

for round ducts Ø 160 mm
with facade protection ring,
Claw fastening and insect protection
Description: 1/BE 180 sanded
Description: 1/WE 180 white
Description: 1/AZ 180 anthracite



Metal grille Ø 175 mm

for round ducts Ø 125 - 160 mm,
Insect screen, pluggable
Description: 1/RME 175 stainless steel
Designation: 1/RMK 175 copper



Plastic grille Ø 115 mm

for round ducts Ø 90 - 100 mm,
Insect screen, with claw fastening
Description: 1/BE 115 sanded
Description: 1/WE 115 white
Description: 1/AZ 115 anthracite



Metal grille □ 228 mm

for round ducts Ø 160 mm,
Insect screen, pluggable
Description: 1/QME 228 Stainless steel
Designation: 1/QMK 228 copper



Metal grille Ø 150 mm

for round ducts Ø 80 - 125 mm,
Insect screen, pluggable
Description: 1/RME 150 Stainless steel
Designation: 1/RMK 150 copper



Two-channel outer hood aluminium

(H x W x D) 235 x 205 x 72 mm
for round ducts Ø 160 mm, insect screen,
with sound insulation, for screwing.
Increase of the standard sound level difference
by up to 6 dB.
Description: 1/HAZ-2 anthracite*
Description: 1/HWE-2 white*



Outer hood aluminium

(H x W x D) 170 x 140 x 72 mm
for round ducts up to Ø 105 mm, insect
screen, with sound insulation, to screw.
Increase of the standard sound level
difference by up to 6 dB.
Description: 1/HWE 115 white*
Description: 1/HAZ 115 anthracite*

new



Universal hood

Suitable for all one- and two-channel units
of the 160 series and Ne^{xt}, recyclable plastic,
(H x W x D) 235 x 213 x 74 mm, UV-resistant,
for round ducts Ø 160 mm, insect screen,
with sound insulation, for screwing.
Increase of the standard sound level difference
by up to 6 dB.
Description: 1/KAZ anthracite
Description: 1/KWE white



Outer hood aluminium and stainless steel

(H x W x D) 235 x 205 x 72 mm
for round ducts Ø 160 mm, insect screen,
with sound insulation, to screw. Increase
of the standard sound level difference by
up to 6 dB.
Description: 1/HWE white*
Description: 1/HAZ anthracite*
Description: 1/HES stainless steel brushed



Two-channel variants for e⁹⁰ and Ne^{xt}

*powder-coated

Representatives

Germany



- Baden-Württemberg
- Bavaria
- Berlin, Brandenburg
- Franconia
- Hamburg, Schleswig-Holstein
- Hesse, Western Franconia, North Baden
- Lower Saxony, northern North Rhine-Westphalia
- Mecklenburg-Western Pomerania
- Rhineland-Palatinate, Saarland
- Saxony
- Saxony-Anhalt
- Southern North Rhine-Westphalia
- Thuringia

Representatives

International



- Australia
- Austria
- Canada
- Chile
- China
- Cyprus
- Czech Republic
- Denmark
- Great Britain
- Greece
- India
- Ireland
- Italy
- Latvia
- Lithuania
- Malta
- Netherlands
- New Zealand
- Norway
- Poland
- Portugal
- Romania
- Switzerland
- Slovakia
- South Korea
- Spain
- Thailand
- USA

**LUNOS Lüftungstechnik GmbH & Co. KG
für Raumluftsysteme**

Wilhelmstraße 31 · 13593 Berlin
PO Box 200454 · 13514 Berlin

Phone +49 30 362001-0
Fax +49 30 362001-89

info@lunos.de
www.lunos.de



WWW.LUNOS.DE